

Article number: 03441240

Description: Fluro Rod end GE 240EC-2RS

Measures

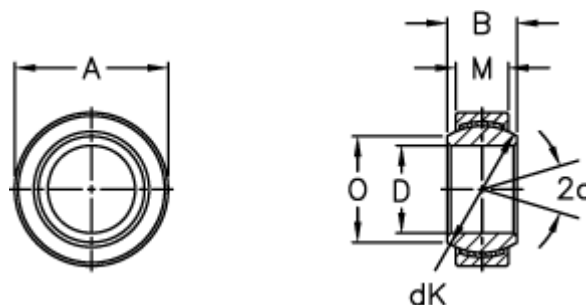

A = 340 0 -0,040

B = 140

D = 240 0 -0,030

dK = 300

Dynamic load C (kN) = 4800

M = 100

O = 265.3

Static load C0 (kN) = 9600

Tilt angle = 8

Weight = 39400